

AGS MerlinGuard



16 Channel Toxic, Combustible & Refrigerant Gas Detection Control Unit



INSTALLATION & OPERATION

Please read these instructions carefully before use and retain for future reference.
These instructions can also be downloaded in electronic form on the product website.



americangassafety.com

CONTENTS

IMPORTANT INFORMATION	3
INSTALLATION	4
General Information	4
Coverage.....	5
Mounting Instructions	5
Electrical Connections Overview.....	6
Configuration Settings.....	8
OPERATION	9
First Power Up.....	9
Gas Detection Detailed View.....	9
Status Indications.....	9
Modbus Network Rescan.....	9
Manual Output-1 Boost	9
Home Screen Alarm Indications.....	10
Temperature Alarm Indications.....	10
Silence & Reset.....	10
MAINTENANCE	11
Cleaning.....	11
Service Mode.....	11
TECHNICAL SPECIFICATION	12

IMPORTANT INFORMATION



Take extra care where this symbol is used to understand the nature of any potential hazards and how to avoid them.

- ⚠ Ensure that this manual is read and understood before installing / operating / maintaining the equipment.
- ⚠ The information contained within this manual should be referenced for typical installation and operation only.
- ⚠ For site specific requirements that may deviate from the information in this guide – contact your supplier.
- ⚠ If the equipment is used in a manner not specified by the manufacturer, the safety/protection provided by the equipment may be impaired.
- ⚠ Isolate the equipment from all hazardous live power sources before opening the cover.
- ⚠ This device is designed for indoor operation only.
- ⚠ It is recommended that this device be commissioned upon installation and serviced annually.
- ⚠ It is NOT designed to detect smoke, fire or other hazards and should NOT be used as such.
- ⚠ This device helps to provide operational controls upon early warning of the presence of gas, usually before a healthy adult would experience symptoms.
- ⚠ This early warning is possible provided your alarm is located, installed, and maintained as described in this manual.
- ⚠ This device requires a continual supply of electrical power – it will not work without power.
- ⚠ This device should not be used to substitute proper installation, use and / or maintenance of fuel burning appliances including appropriate ventilation and exhaust systems.
- ⚠ This device does not prevent nitrogen dioxide or carbon monoxide from occurring or accumulating.
- ⚠ Actuation of your alarm indicates the presence of dangerous levels of gas.
- ⚠ Seek fresh air supply and contact your local gas emergency service should you suspect a gas leak.
- ⚠ This device may not fully safeguard individuals with specific medical conditions.
- ⚠ If in doubt, consult a doctor / physician.
- ⚠ Your product should reach you in perfect condition, if you suspect it is damaged, contact your supplier.
- ⚠ Concentrations of alcohol found in many products may damage, deteriorate, or affect the gas sensing elements such as wine; deodorants; stain removers and thinners. Other gases and substances to avoid are corrosives (i.e., chlorine & hydrogen chloride); alkali metals; basic or acidic compounds; silicones; tetraethyl lead; halogens and halogenated compounds!

Manufacturer's Warranty

The manufacturer warrants to the original consumer purchaser, that this product will be free of defects in material and workmanship for a period of 3 Years from the date of purchase. The manufacturer's liability hereunder is limited to replacement of the product with repaired product at the discretion of the manufacturer. This warranty is void if the product has been damaged by accident, unreasonable use, neglect, tampering or other causes not arising from defects in material or workmanship. This warranty extends to the original consumer purchaser of the product only. Any implied warranties arising out of this sale, including but not limited to the implied warranties of description, merchantability and intended operational purpose, are limited in duration to the above warranty period. In no event shall the manufacturer be liable for loss of use of this product or for any indirect, special, incidental, or consequential damages, or costs, or expenses incurred by the consumer or any other user of this product, whether due to a breach of contract, negligence, strict liability in tort or otherwise. The manufacturer shall have no liability for any personal injury, property damage or any special, incidental, contingent, or consequential damage of any kind resulting from gas leakage, fire, or explosion. This warranty does not affect your statutory rights. During the above warranty period, your product will be replaced with a comparable product if the defective product is returned together with proof of purchase date. The replacement product will be in warranty for the remainder of the original warranty period or for six months – whichever is the greatest.

Disposing of Electrical & Electronic Equipment (WEEE)

When this product has reached the end of its life it must be treated as Waste Electrical & Electronics Equipment (WEEE). Any WEEE marked products must not be mixed with general household waste, but kept separate for the treatment, recovery and recycling of the materials used. Please contact your supplier or local authority for details of recycling schemes in your area.

INSTALLATION

General Information

- ⚠ Refer to your AGS Detector manual for important information regarding coverage, location and positioning including areas and conditions to avoid!
- ⚠ Installation must be in accordance with recognised standards in the country concerned, for North America, NEC / CEC regulations should be followed!
- ⚠ Access to the interior of the controller, when carrying out any work, must only be conducted by trained personnel!
- ⚠ Before carrying out any work ensure local regulations and site procedures are followed!
- ⚠ The use of sounder strobes is highly recommended!
- ⚠ Consult with local codes for the specific requirements!

The MerlinGuard controller is designed for installation and paired with fixed point AGS Detector TFTs that will be linked via Modbus RTU protocol back to the controller and monitor the detectors in numbers up to 16 (per controller) and automatically control ventilation systems according to gas levels with an optional temperature level control. The MerlinGuard can activate both the exhaust fan(s) and the air intake device(s) such as outside air louvers/dampers and make up air units.

The MerlinGuard will make or break a dry contact internally on relay terminals [Output-1] and a second contact on [Output-2]. This is to have a live feed to the ventilation system wired through the contact so that the controller can activate ventilation systems; this can be either via a direct live feed or via a run signal.

Another output relay will energise after [Output-2] has been active for an extended period. This is used for a link to a BMS or other external indication device. The controller also has a 0-10vdc output to allow the controller to drive VFD's based on gas level outputs.

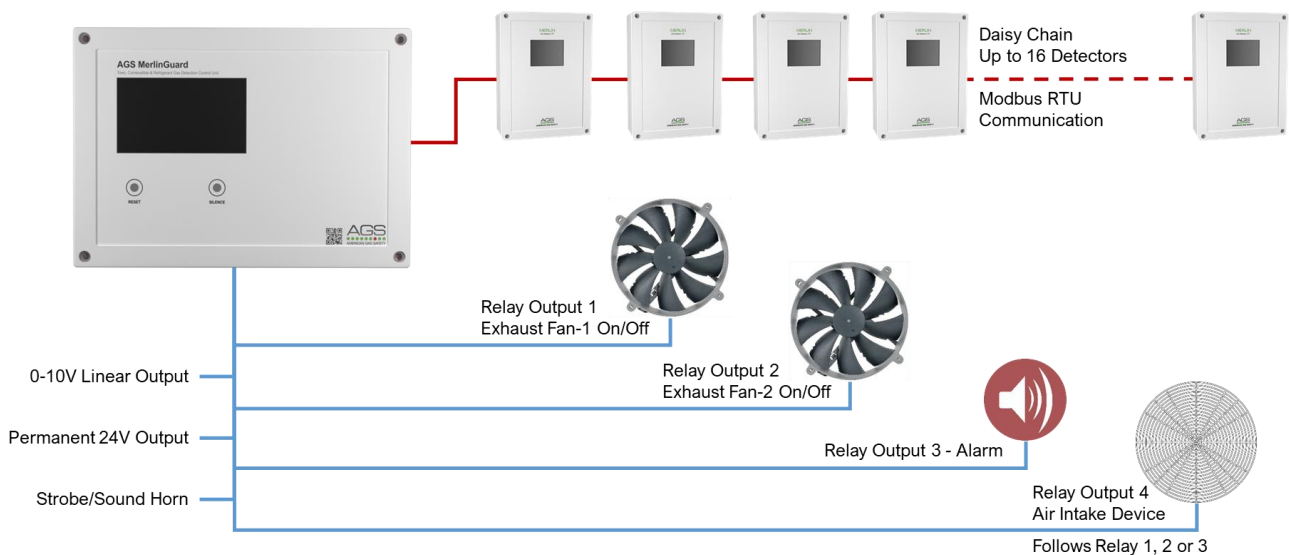

Addressable AGS TFT detectors are daisy-chained through a RS-485 RTU communication protocol to the controller. The controller must be installed and located in accordance with applicable regulations. out of reach of the public, close to the motor control centre or in connecting offices.

Easy accessibility is recommended for both status observation and alarm purposes.

Coverage

There are no official figures of area coverage for a detector; however, 50 feet (15.2 metres) per detector or 7,580 square feet (704.2 square metres) per detector is a reasonable general guide therefore multiple detectors may be required to adequately monitor and protect property and/or persons.

Installation of the system, including detectors must be carried out by a licenced and insured contractor, installed, and located in positions determined by those who have knowledge of gas dispersion, process plant systems and any equipment involved. Seek advice where necessary, in consultation with both safety and electrical engineering personnel.

Consider air flow patterns within the area, AGS TFT detectors must be installed in the correct orientation as per the manufacturer's specification, and ease of access should be accounted for to allow for any forms of maintenance throughout its operational life.

For installations in North America, the National Electrical Code (NEC) should be strictly observed, and all appropriate local and national regulations should be observed.

Mounting Instructions

- ⚠ **Where cable glands/conduits are used for wire entry, use no bigger than 20mm (3/4") separated by at least 20mm (1/2")!**
- ⚠ **Any parts that form part of the connections/installation must have a minimum UL fire-retardant rating!**
- ⚠ **Restrain the hazardous live wiring from accidental loosening to prevent wires from moving after installation and touching parts of opposite polarity or at low voltages!**
- ⚠ **Designed for surface mounting, it must be installed by a licensed, insured contractor!**

Carefully remove the front cover from the unit by unscrewing the four M6 hex bolts located at each corner. To do this – use the socket wrench provided.

Ensure the wall surface is solid and flat to prevent base distortion and mark the four 6mm (0.236") screw holes located on the back of the enclosure to the wall.

Use a suitable screw/bolt (M4x30min) and appropriate expanding plug to fix the back of the enclosure to the wall surface. Drill out as necessary ensuring all swarf is removed from the box and holes have smooth edges.

After executing the mounting and the electrical connections – replace the front cover and insert the security caps over the four M6 hex bolts.

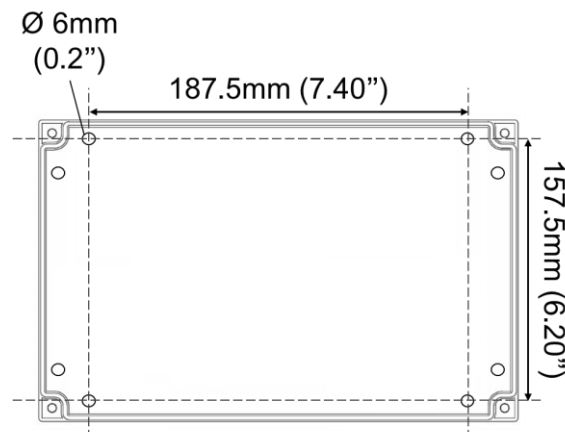

Electrical Connections Overview

- ⚠ Access to the interior of the controller, when carrying out any work, must be conducted by a competent person!
- ⚠ External wiring routed through the 'volt free' relays (Output 1 & 2, Alarm and Damper) require double insulated wiring!
- ⚠ For Modbus communications, a shielded cable is used!
- ⚠ Isolate the equipment from all hazardous live power sources before opening the cover!
- ⚠ A switch or circuit breaker must be included in the installation! It must be suitably located and easily reached to allow for disconnection of the equipment! It must be marked as the disconnecting device of the equipment!

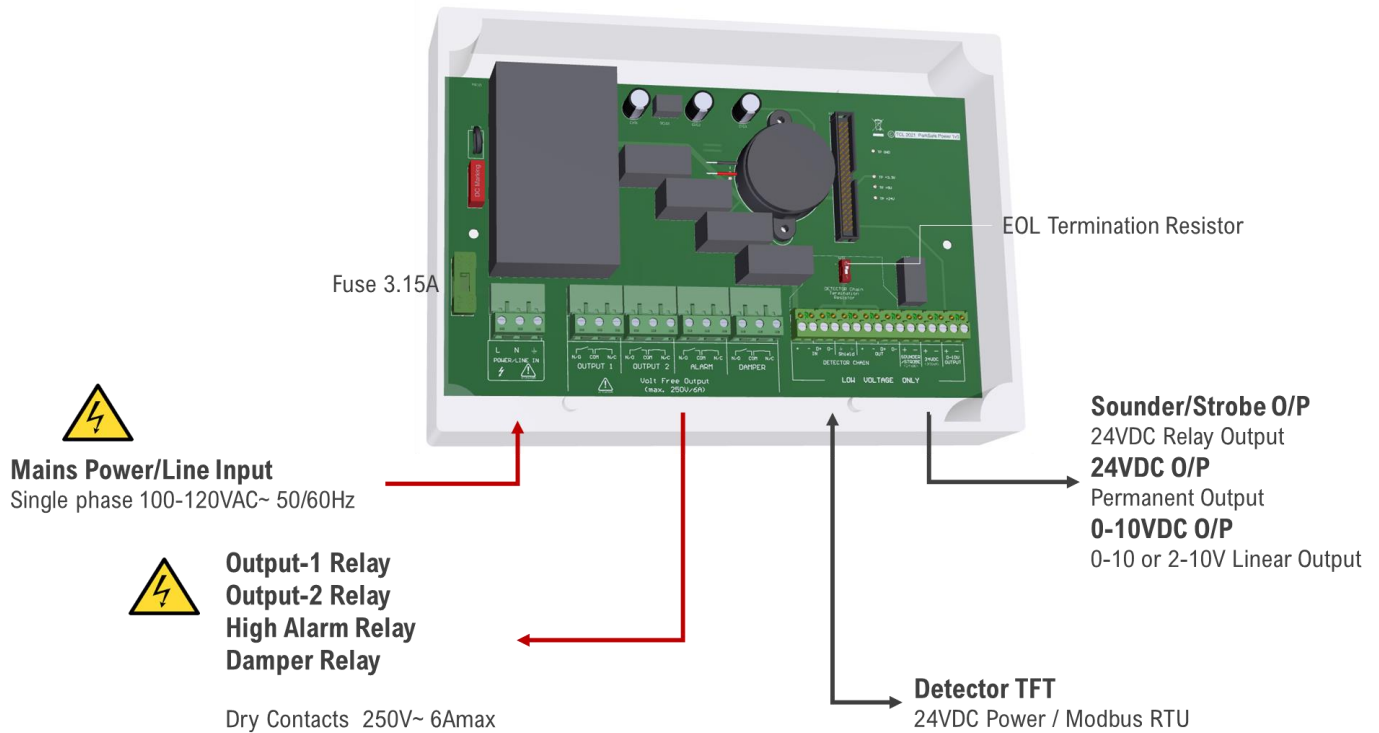

Power/Line Input The controller requires a single-phase power supply of 100-120VAC. When power is introduced to the controller, a red LED will illuminate on the front of the controller (AGS Logo) and the screen will power up.

Output-1 Relay Switches after 2 minutes when a detector TFT reaches a 'pre-alarm' condition.

Output-2 Relay Switches when a detector TFT reaches an 'alarm' condition.

Alarm Relay Switches following [OUTPUT-2] when a detector TFT remains in an alarm condition. A delay time of 0, 5, 10, 15, 20 or 25 minutes is selectable in the configuration settings.

Damper Relay Configurable. Switches together with either [Output-1], [Output-2] or [Alarm] relays.

Detector TFT

- ⚠ Ensure the equipment is configured in a single bus topology, connecting multiple buses in parallel or branching multiple units from the main bus, may introduce impedance mismatches, reflections and/or signal distortions.
- ⚠ Ensure D+/D- signal polarity is maintained throughout the network.
- ⚠ Reversing the [D+] and [D-] connections of any device can lead to the whole system to stop working owing to reverse polarity found on the terminals.
- ⚠ Ensure the 120-ohm chain termination resistor is switched on at each end of a chain/bus!
- ⚠ Detectors connect to either [IN] or [OUT] terminal sets!

24Vdc power and RS-485 data connections to AGS detectors. Daisy chain wires running to additional detectors – 16 max per cable run. First and last device in the bus/chain requires a termination resistor. Use termination switch at each end.

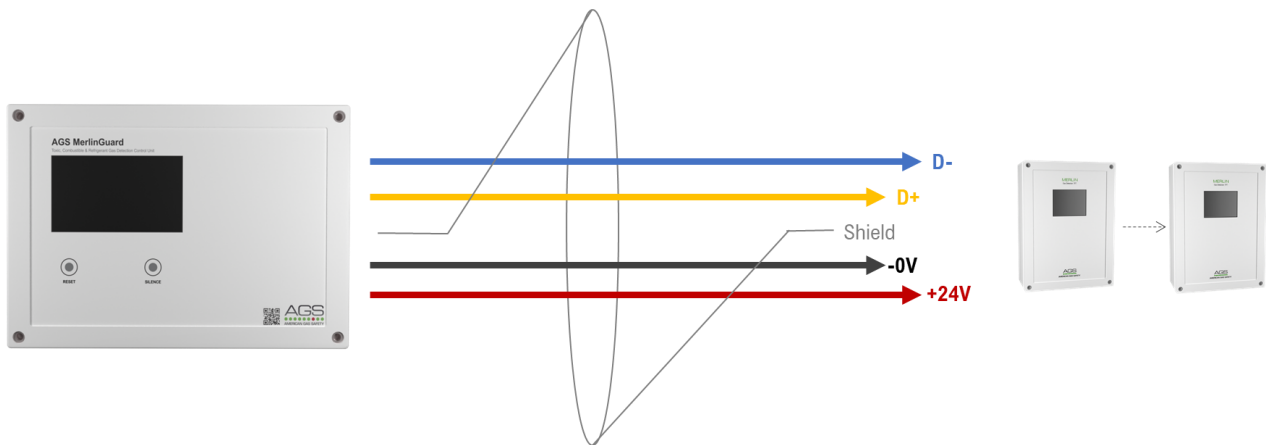

Recommended 3-core, 2 twisted pair + ground, shielded cable with 120 Ω characteristic impedance.

Consider voltage drops due to cable resistance for long distances. Cable specifications ultimately determine the distance the sensors can be mounted away from a control panel or power supply. Strip cables as short as possible.

Shield terminals [Shield] are used to maintain shield line only. Cut and tape on last device.

- ⚠ Always refer to your Gas Detector Manual for more information.

Sounder/Strobe

This relay output (24vdc) is for external sounder alarms/ strobe lighting and will activate on alarm.

24vDC

This is a permanent 24Vdc power output for external auxiliary devices. Max output: 200mA.

0-10V Output A linear +10V output is normally used to regulate external fan speed controllers (supplied separately). The MerlinGuard features a configurable 0-10V (default) or 2-10V linear output.

During normal operation, this voltage output is proportional to the main gas alarm setpoint. The detector with the highest concentration (closest to the alarm setpoint) will take the priority and drive the 10V output.

Refer to your detector main alarm setpoint.

Main-Alarm Level %	0-10V	2-10V
0%	0V	2V
50%	5V	6V
100%	10V	10V

Configuration Settings

⚠ When changes are made – turn the settings switch off and the controller will automatically restart!

Turn on the [Settings] switch located on the display circuit board. The screen will display the settings menu. The MerlinGuard controller has a touch screen, which allows the engineer/user to configure the system.

Adjust the screen brightness

(Press or slide the cursor up and down).

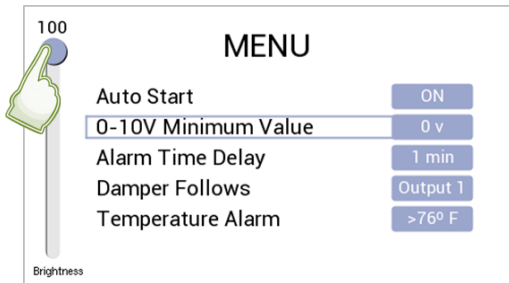

Change/select option.

(Press the blue option box or press and hold)

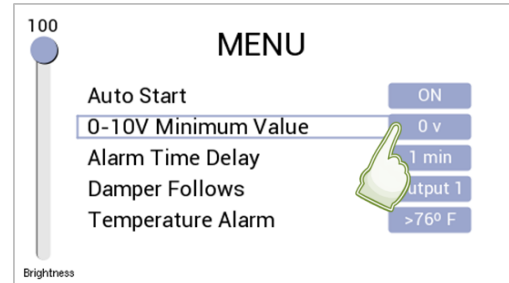

FUNCTION	OPTION	Explanation	Default
Auto Start	-ON -OFF	ON: In the event of an unscheduled power loss/outage - the controller will automatically restart when power is restored.	-ON
0-10V Minimum Value	-0V -2V	0-10V linear scale either 0-10V or 2-10V based on detector concentrations measured. Highest will drive the signal.	-0V
Alarm Time Delay	-Off (0) -5 -10 -15 -20 -25	Time (minutes) for alarm relay to switch when detectors reach an alarm condition. (Following Output-2 Relay).	-Off (0)
Damper Follows	-Output 1 -Output 2 -Alarm	Damper relay switches together with either: [Output-1], [Output-2] or the [Alarm] relay.	-Output 1
Temperature Alarm	- >68 - 86°F -Off	All Relays except Alarm will switch when the temperature exceeds the selected value. Select Off to disable function. Relays switch back when the temperature reaches 4°F below selected threshold.	-Off

OPERATION

First Power Up

Upon connecting mains power, the MerlinGuard controller will 'warm up' for approximately one minute. After the controller has initialised, the system will begin searching and establishing the network with Detectors.

Gas Detection Detailed View

To access detector status screens, press the 'Gas Detection' section on screen any time. Switch between pages by touching the relevant page button at the bottom of the screen.



Each page will display up to four detectors:

- The network address configured on each detector.
- The unique serial number for that detector.
- The target gas that detector is monitoring.
- The status of gas levels, errors, and messages.
- The concentration value of gas detected.

ID	Serial Number	Gas	Status	Value
9	123456789103	CO	GOOD	2 ppm
10	123456789103	H	GOOD	0.4 LEL%
11	123456789103	CO	GOOD	47 ppm
12				---X---

Labels a-e point to: a (ID), b (Serial Number), c (Gas), d (Status), e (Value).

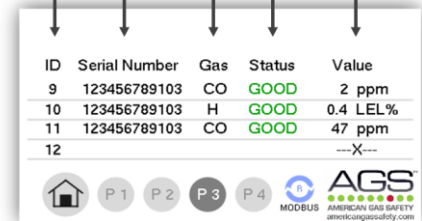

To return to the main screen, press the home button on screen.

Status Indications

GOOD	Gas levels are safe / No error conditions.
PRE-ALARM	Gas at pre-alarm levels.
ALARM	Gas at main alarm levels.
FAULT	Gas detector fault.
END OF LIFE	The gas detector has reached the end of its expected lifecycle.
SERVICE	Annual maintenance/bump test/calibration reminder.

Modbus Network Rescan



At any time, the user can rescan and refresh the Modbus communication data if there is a bad connection in the chain by pressing the icon on screen. When pressed the system will search for all signals connected to the controller i.e., gas detectors without the need to reset the system.

Manual Output-1 Boost

The manual boost feature is activated by pressing OUTPUT 1, simulating a pre-alarm condition. When enabled, the controller will send 10V. To turn off and return to a normal condition, re-press OUTPUT 1.

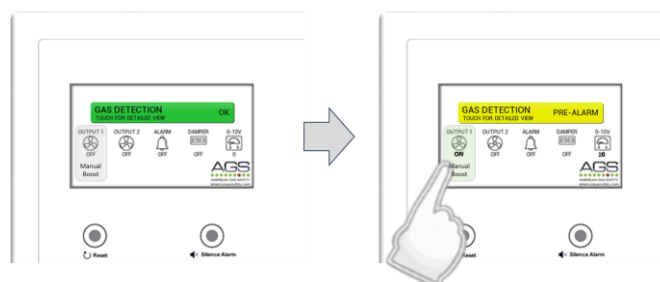

Home Screen Alarm Indications

System OK

System under normal/safe operating condition.

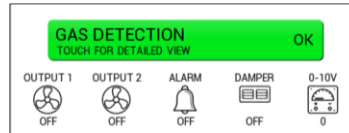

- All outputs normal/off

Pre-Alarm condition

When gas levels reach pre-alarm values.

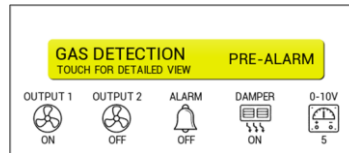

- Output-1 On
- Damper (Selectable On/Off)

Alarm Delay condition

When gas reaches dangerous alarm values.

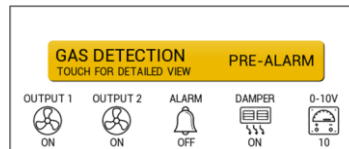

- Output-1 On
- Output-2 On
- Damper (Selectable)

Alarm condition

Gas levels beyond the alarm delay condition.



- Output-1 On
- Output-2 On
- Alarm On
- Damper On
- Gas detector ID shown.
- Internal buzzer will sound.

Temperature Alarm Indications

- All outputs will remain active until the temperature (monitored by detectors drops below 4°F of the specified threshold – adjustable in the configuration settings.

Temperature Status & Icon

Temperature has exceeded pre-set value.

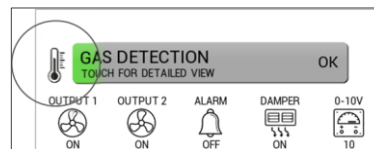

- Output-1 On
- Output-2 On
- Damper On

Silence & Reset

To silence the internal buzzer in alarm – press the Silence button on the front of the controller. This will also silence any external audio strobe/sounders connected to the controller.

If the system reaches alarm condition – the controller will need resetting when the gas levels return to a safe concentration. Check the detector status to identify the gas detected and if levels have returned to a safe condition - reset the system.

MAINTENANCE

Cleaning

- ⚠ Concentrations of alcohol found in many products may damage, deteriorate, or affect the gas sensing elements such as wine; deodorants; stain removers and thinners.
- ⚠ Other gases and substances to avoid are corrosives (i.e., chlorine & hydrogen chloride); alkali metals; basic or acidic compounds; silicones; tetraethyl lead; halogens and halogenated compounds!

Keep your MerlinGuard system in good working order.

- Remove any dust/debris from the outer enclosures regularly using a slightly damp cloth.
- Never use detergents or solvents to clean your device(s).
- Never spray air fresheners, hair spray, paint or other aerosols near the detectors.
- Never paint the device(s). Paint will seal vents and interfere with the equipment.

Service Mode

Access service mode by pressing the AGS logo on the controller (home screen logo only). The screen will display a service message prompt. Press Yes.

Note: All alarm signals/outputs will be inhibited for fifteen (15) minutes. Proceed to service gas detectors. Upon completion – exit service mode by pressing the 'Exit' button.

Always refer to your gas detector manual for more information.

Please pass this manual to the system owner / user.

Date of Installation:	
Installation Location:	
Organisation:	
Stamp/Signature of the installer:	

We recommend all AGS equipment be commissioned by competent/trained engineers to ensure correct installation and operation. We strongly recommend the response and alarm signals are tested and validated once installed. This will ensure the equipment performs as intended and is free from any unforeseen damage caused by transit/installation.

Every effort is made to ensure the accuracy of this document; however, AGS can assume no responsibility for any errors or omissions in this document or their consequences. AGS would greatly appreciate being informed of any errors or omissions that may be found in the content of this document. For information not covered in this document, or if there is a requirement to send comments/corrections, please contact AGS using the contact details given below.

TECHNICAL SPECIFICATION

Mechanical	Mounting	Wall Mounted
	Size (W x H x D)	7 x 10 x 3"
	Weight (Max)	36oz Max
	Enclosure	ABS UL Flame Retardant
	Power Rating	Nominal 110-120VAC, (90-250V AC), 50-60Hz
	Internal Fuse	T3.15A L250V
	Communication	16 Channels Max
	Power Consumption Max	14.5W Full Load
Environmental	Operating Temperature	14 to 122°F
	Storage	32-86°F
	Humidity	0 to 95% RH (continuous) non-condensing.
	Atmospheric Pressure	80 to 110Pa
	Altitude	<6562ft
	Installation Cat (110V Voltage)	II (Class 2) Pollution Degree 2
	Digital Networks	MODBUS RTU
Relay Outputs		4x Dry Contacts 6A @ 250VAC (non-latching) 1x 24VDC Switching. 1x 24VDC Permanent 1x 0-10V Linear
Cable Spec	Typical	<p>Power~#18-12AWG-Tinned Copper. Current Rating: 1A Minimum. Voltage:100-250V~. Wire Stripping Length 6-7mm</p> <p>Relays: ~#18-12AWG-Tinned Copper. Current Rating: 6A Voltage: 100-250V~ Wire Stripping Length 6-7mm</p> <p>For field connections use wires suitable for at least 90°C (194°F) Detector: #15AWG Power Pair #18AWG Data Pair-Tinned copper.</p> <p>Other: #18-14AWG-Tinned Copper.</p>
User Interface	Language	English
	Display	4.3" TFT Touch Screen
	Indication	TFT visual. Green: Normal; Yellow: Pre-Alarm; Amber: Alarm Delay; Red: Alarm Relay Outputs On/Off Gas Detection Status.
	Buttons	Silence alarm and Reset system.
Conformance	Safety & Electromagnetic Compatibility	IEC 61010-1:2010 + AMD1:2016; EN 61010-1:2010 +A1:2019; UL61010-1/2012/R:2019-07; CAN CSA C22.2 No. 61010-1-12/A1:2018-11 EMC EN 61326-1:2013

American Gas Safety LLC

www.americangassafety.com

Head office:

6304 Benjamin Road, Suite 502, Tampa, FL 33634

Tel: (727) 608-4375

Email: info@americangassafety.com



American Gas Safety LLC is the owner of this document and reserves all rights of modification without prior notice.